

A COMPREHENSIVE WOMEN'S SAFETY PLATFORM OFFERING SECURE LOGIN, EMERGENCY PANIC, NEWS ALERTS, ROUTE NAVIGATION WITH POLICE STATION PROXIMITY, INCIDENT REPORTING

Dr.E.Thenmozhi

Associate Professor, Department of Information Technology, Panimalar Engineering College, Chennai,India

Sneha k

Department of Information Technology, Panimalar Engineering College, Chennai,India

Amritha k

Department of Information Technology, Panimalar Engineering College, Chennai,India.

Nisha R S

Department of Information Technology, Panimalar Engineering College, Chennai,India

ABSTRACT

A significant challenge confronting by society is women's safety. The frequency of crimes targeting women, including sexual assaults, domestic abuse, and dawn teasing, is rising daily due to different social or ethnic reasons. Using a smartphone to seek assistance in matters of security can be one of the simplest options such as across the globe method of handheld data transmission and the global positioning system (GPS) .It was determined that in order to properly solve the issue, technologies emphasising automatic set-up warning production in addition less individual input additionally higher accuracy must be developed, despite delivering noteworthy research in the underlying subject .It makes advantage of the GPS tracking technology to give registered contacts an easy and quick way to find out if the individual has encountered troubles and to get in touch with them. It also has safety features like Disaster hotlines which could possibly contacted straight through phone to emergency services in accordance with the circumstances encountered with women in order to protect them, a live location of the victim that can assist by a law enforcement provides contextual and identifying information, and an alarm for notify individuals of all kinds misbehaviour.

Keywords: Women's safety, SOS, GPS, human safety, Android, security devices.

INTRODUCTION

Women's security is becoming a serious concern in this day and age. Women encounter harassment at work, at home, and in educational institutions. A lot of women are terrified to leave their comfort

zone. Anywhere and at any time, critical circumstances can occur. An Android app that can assist women in need in getting aid or quickly getting out of a difficult circumstance may be helpful in these situations. The fundamental issue with the way the police handle these situations is that they can't always react quickly to distress calls. These restrictions include the victim's inability to contact the police discreetly and with confidence, as well as their ignorance of the crime's location. to enable the lifting of these restrictions. The Women's Safety Application is an utilization for smartphones that makes it trustworthy for ladies to get in touch law enforcement For case of a crisis. In the event of an emergency. Yes, indeed risky to women in particular for go only themselves around nighttime as they lack the same level of power as men. One of the finest ways for lower you're chances Recognizing your risk being victim for an assault your risks and take advantage of tools that can help you escape dangerous circumstances. You may Use alarm system to lower the danger while getting help anytime needs to be on your mobile device.

LITERATURE SURVEY

“ABHAYA: A WOMEN'S SAFETY ANDROID APP”. In order to stop events similar to the Delhi Abhaya case from reoccurring again, this paper proposes the Android application "ABHAYA" for women's safety. This program tracks the location of the disturbed individual via a 3G or 2G data connection and texts the URL of their location to registered contacts from a smartphone. Every five minutes, this message is sent to the designated contacts until the "stop" option is pressed. The application opens and calls the first registered contact when the woman presses the "start" button. It then sends a message to each registered contact that includes the device's location URL. It continuously transmits location messages every five minutes and the possibility of tracking the location of a individual frequently.[1]

The best defense against becoming a victim of a violent crime (pillage, rape, sexual assault, and domestic abuse) is awareness of it and assistance in leaving dangerous situations, say the authors of "S-ZONE: A SYSTEM FOR WOMEN SAFETY & SECURITY SYSTEM." The S-site software, which was developed for the Android platform to help women stay safe by harnessing the most modern developments in mobile technology, is described in this essay. This program makes it easier for emergency personnel to locate and rapidly remove a vulnerable person from dangerous situations by using GPS to monitor the root device.[2]

"SHIELD: Application for Personal Security" is an application that assists a user in protecting, saving, and shielding himself from danger, as the name suggests. By instantaneously sending a message with the device's location to all registered contacts, it enables real-time tracking of the woman's whereabouts and the provision of required assistance. Tracking the position is the foundation of the system's primary feature. It is fully dependent on real-time geographic location monitoring and also updating on the website. Updates in real time to the SHIELD user area are decided upon and published online. The update appears on the webpage in 0.5 seconds, depending on the internet connection.[3]

Given that most individuals always have their smartphones with them, the writers of the article "Women Safety Android App" [4] say that one of their main objectives in developing this software was to provide safe conditions for smartphones. It is informed that in order to alert the police and specific contacts, the victim needs to press the power button twice rather than pressing the SOS button on the screen, they should do so regardless of whether they have GPS or the internet. and after a minute, the system would relay the victim's current location—that is, a better location—if the user or victim moved. One of the program's main features, according to some reports, is giving the police a control panel so they possess an interface through which the police and deportees can check whether or not there are any cases like this. When the victim presses the power button, their location is highlighted, making it simple for police to go to them and rescue them.

An example of the functioning of the GPS-based "Women Safety Mobile App" is given by the research's authors [5]. This system starts up when the woman who used her fingerprints to authorize the device scans them. The woman must then continually scan her finger print every minute; if she doesn't, the device will sound a buzzer to alert everyone nearby to the emergency and send an SMS message to the registered phone with its location. In the event of an emergency, the woman only needs to cease scanning her fingerprint. The system is operated by the device using a microcontroller-based circuit, GPS, and GSM modem. This approach is quite helpful when a woman is unable to use or activate the emergency feature. The SMS alert message includes someone's GPS location and can be sent directly to a chosen group of contacts so they can help her when needed.

This survey's primary focus was on the methods for identifying human body sensors, and it also emphasized the shortcomings of earlier research. In another research, a survey and comparison of earlier studies on the subject of guardian devices for women's safety were offered.[6]. To get notifications, the researcher created a unique guardian device. The gadget is made to function with sensors, and in order to warn a guardian when a woman is in danger, she must press the button. Even while the gadget appears to be a useful tool for prospective victims, there is a flaw in that the victim must activate the device, which leaves the person in danger usually trapped and unable to take certain specified action. A survey of research on new and developing technology for women's safety and protection was provided by reference [7]. The investigators collected information and looked for women's safety gear online, revealing both emerging and newly developed technology. A thorough assessment of the literature on the development of features that are already present in safety devices for women. The classification presented for the analysis, however, emphasizes several sensors and key characteristics of women's safety equipment. On the other hand, the researchers in [9] introduced the Woman Safety System (WSS), which is specifically made to safeguard women and provide alerts in case of danger. The WSS gadget is not worn wherever, any time; it is meant to be a smart jacket. Still, the paradigm this study presents is flexible enough to work with a wide range of devices in any circumstance.

In accordance with studies, there are numerous applications and preventative measures for women's safety readily available in the market. AppSoftIndia created an application layout for women's safety. The application's primary characteristics are the user's need to save details.

Included in those details are the recipient's email address, mobile number, user password, and SMS message. The application is then started as a "widget" so that each time the user taps it, it sends out a notification to the receiver. Another crucial component of a mobile number is the application's capacity to record ambient noise for about 45 seconds and then text the receiver with the user's position coordinates. In the same way, the applications [10][11][12] were created specifically with women in consideration.

There is no application that promises complete safety. Every gadget has benefits and drawbacks of its own. It turns out that portable devices are uncommon on the market, as opposed to mobile applications. The results generated ideas for developing a mobile application and a portable gadget by pointing out certain essential components.

"The Safety of Women" The app's developer is AppSoftIndia. One of the primary purposes of the app is to remind the user of certain data. These details include a text message, the recipient's email address and cellphone number, and the user's email address and password. Next, the application loads as a "widget," and when the user presses it, it alerts the receiver. Another noteworthy feature of the software is its capacity to record background noise for approximately 45 seconds and then send a text message to the recipient's phone along with the user's GPS coordinates.

[14]POLICE NEARBY: Big Systems developed this software in 2013. The goal of this law enforcement nearby scanner Android app is to allow the community to get more involved directly from their Android mobile smart phones by connecting residents and students to the

most nearby police stations in each city with just one click. Law enforcement agencies at all levels local, state, municipal, or college can enhance constituent services and communication by using the Police Scanner Android App. The Police Nearby app can be downloaded for free without registering. [15]

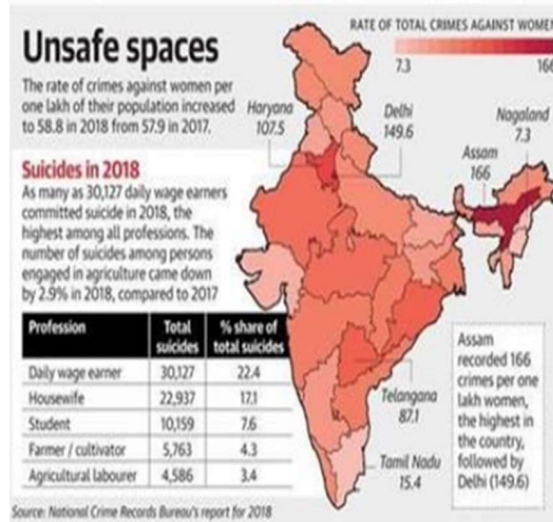

Figure 1. Rate of total crimes against women

"ALARM SCREAM" In November 2013, Go Pal AppMaker developed the Android application Scream Alarm. This software allows users to generate a loud enough scream in case their lungs are incapable of producing one during an emergency. The woman's fake scream is a great way to stop potential troublemakers from getting serious. If someone presses or touches the phone, this program does nothing more than make it scream loudly like a lady.

[16] While some of the aforementioned programs are exclusive to Android or Windows, others can be used with iOS, Windows, and Android. The Security Alert app, however, is only designed to function on the Android operating system; nonetheless, it might potentially be extended to support the Windows and iOS operating systems as well. An open Linux kernel was used in the development of the open-source. With the use of a virtual machine, Android is designed to maximize the hardware and memory capabilities of the mobile environment. Android is sufficiently expandable to incorporate new state-of-the-art technology as they appear. As a result, the Android platform will never stop evolving as a development group in order to create cutting-edge mobile applications.

SYSTEM ARCHITECTURE

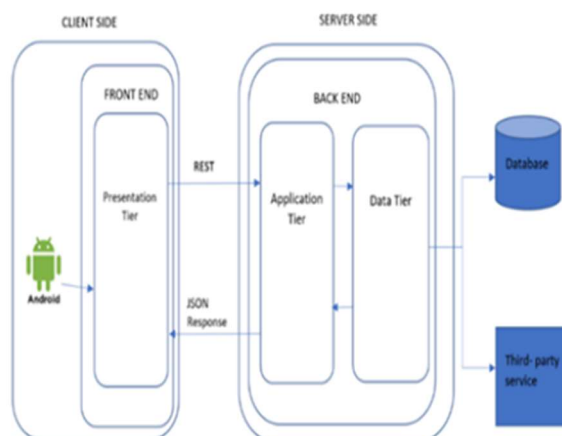

Figure 2. Outlook of Women Safety App

This schematic demonstrates the construction of the suggested framework. The client's phone's Internet, [18] GPS for locating the police, and GSM for data transmission via the messaging system are the three primary components required for this program to function. The user is not required to register in order to make use of the program to ensure that there is [13] no waiting period while using it in an emergency. The user is presented with a range of choices, that they can select from based on the circumstances of the moment.



Figure 3. Architecture of Women Safety Application

EXISTING SYSTEM

There are many different applications available to protect women in risky situations. The fact that these apps only deliver alert messages to the contact numbers you've saved is a drawback.

The current systems have made it harder for women to escape their challenging circumstances. Although the GPS tracking module in existing programs can also be used to track the whereabouts of women, it lacks precise range measurements. The prior system did not have the capability of sending alert messages to cell phones in the proximity.

Women's safety solutions that have recently been developed come in a variety of forms, including security systems, wearable technology, and smartphone apps. One idea is that when the victim clicks the power button, a notification be sent to police or specific contacts. After a minute The perpetrator's precise position is sent by the technology. therefore offers more convenient position for the individual using it or victim to navigate between certain systems allow a woman who has has received authorization to capture fingerprints using the gadget. Next, it is recommended that the lady regularly scans your thumbprint for per min. In otherwise, the mobile app will text the given address regarding the woman's position.. If something serious happens, the woman doesn't have to do anything.[16]

The worldwide wireless telecommunications network (GSM)) modem and a GPS unit are built into this system. Every 30 seconds, it sends brief signals to the server with its GPS coordinates. While 802.11 wireless networks are occasionally available, sending a target's geolocation data over wireless networks works best when the target and the tracker are both inside Wi-Fi coverage areas. Location tracking is not feasible if Wi-Fi is unavailable to either the tracker or the target. Because SMS is so widely used, it is consequently a more dependable and adaptable alternative. SMS is a user-pay service, though. The amount of SMS transmissions a tracking system must send in order to maintain the accuracy of its location tracking is high.

The main disadvantages of the existing Sytem is that the target and tracker must be inside the same Wi-Fi coverage region. Despite being a user-pay service, there are a lot of SMS messages sent. It is not possible to track a target's location when neither the tracker nor the target can connect to WiFi.

PROPOSED SYSTEM

This technology combines the Global Positioning technology (GPS) with Short Message Service (SMS) using the innovative Location-Based Delivery (LBD) technique. LBD is made to strike the best possible compromise between keeping accurate location tracking within reasonable bounds and reducing the number of short message transfers. Location prediction, an adaptive thresholds process, and a unique brief text format are the main elements of LBD.

The system's unique brief message format is specially designed to meet its requirements, guaranteeing efficient interaction between the entity being monitored and the monitored goal. This format's purpose is to convey important information succinctly, which enhances the entire system's efficacy. One essential component of LBD is location forecasting, which involves analysing real-time information about the target's bearing, movement speed, and current position. The system makes a prediction about the target's next position by using this information. The target

sends out a brief message to update its location when the difference between its projected and real locations beyond the threshold is exceeded. The tracking procedure is more accurate because to its forecasting components.

One clever component of LBD that adjusts to the monitored entity's shifting dynamics is the dynamic threshold mechanism. This system makes sure that, depending on certain parameters, the trigger for brief message delivery is dynamically changed. When the target's motions are within predicted bounds, this adaptation stops pointless message transfers, maximizing resource consumption and overall system efficiency.

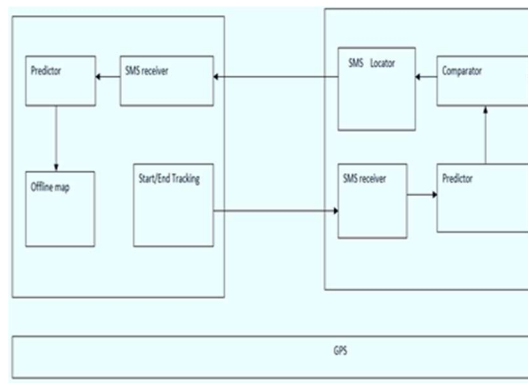

Figure 4. Block diagram of proposed system

In conclusion, the LBD system stands out because to its incorporation of an adaptive thresholds process, position prediction, and unique short message format. These features enable a more simplified and environmentally friendly method of detecting a location by combining GPS and SMS technology.

Advantages of the proposed system are with comparatively fewer messages; it maintains location tracking accuracy sufficiently. The precision of location tracking is maintained by dynamically adjusting the threshold. Quick delivery to clients and finally client satisfaction

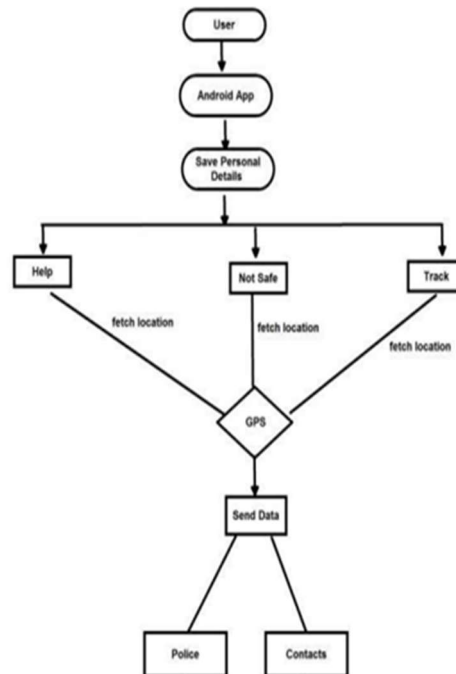

Figure 5. Flowchart of Proposed System

METHODOLOGY

The various components that make up this endeavor are stated here:

Verification: All of the information about the authorized Person is contained in the authentication module. The act of confirming someone's identification by getting privileges and utilizing them to confirm their identity is known as authentication. Authorization the credentials are authentic, starts. The authorizing step constantly follows a verification phase. Absent their logging in & credentials, an individual is unable to check up. On the occurrence the woman happens to be sole one who has been authenticated.

B. Add Emergency Contacts: The individual adds significant contacts in this component. It includes details Include an individual statement: This part receives details from the person using it directly. It contains information on the location. where they are kept.

C. Include an individual statement: This part receives details from the person using it directly. It contains information on the location., phone number, email address, and identity. The database contains the Personal Information.

D. Modify Private Data: An individual has the capacity to amend or modify their individual data inside this section. Details such as personal details, e-mail address, and telephone number may all be changed. The record set has been revised with the new specific data.

E. Informational Text Communication: It is this application's main module. The women's safety element has been introduced to this module. The woman only needs to click on this app if she thinks herself in a precarious circumstance.

With only one click, this software using Geolocation for identifying the location then notifies those specified people using the precise web address in a message for emergencies and the closest police station, directing them to begin the rescue process as soon as feasible.

The suggested approach will notify those in close proximity who have this application by sending them an alert message and playing an alarm sound on the guardian smartphone when the user press the button their phone. Additionally, send a message and sound an alert to the police station, hospital, and contact numbers you've saved in the application. which, with the aid of the Global Positioning System, also displays the user's location [17].

The benefit of the suggested method is that it shields the user from physical harm while also assisting law enforcement in identifying and apprehending the offender. When this upgraded system is eventually implemented in India, any lady would be able to walk roadways fearlessly, regardless of strange times, despite worrying concerning them safety. [19]

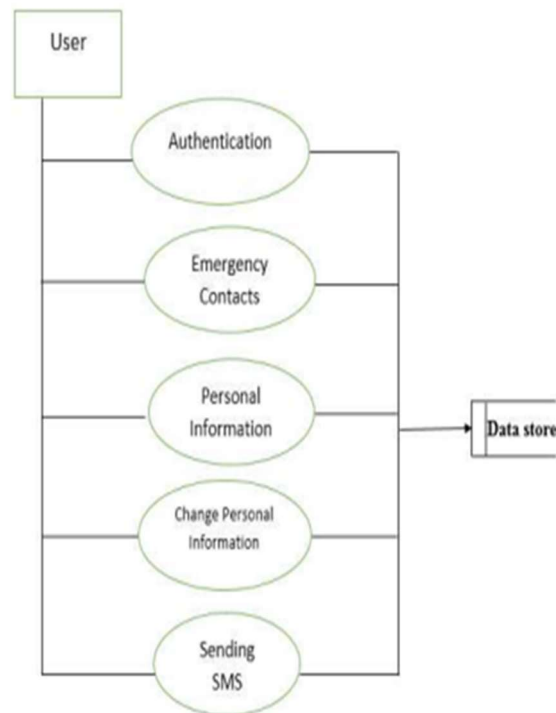

Figure 6. Data Flow Diagram for Women Safety Measures Mobile Application

IMPLEMENTATION

When an individual is having trouble or needs assistance, this Android application comes in handy. The user notices a HELP button when they first launch this program. We might spare phone contacts with a statement as well.

All individual has to do is launch the app, choose the "HELP" option, and ask for assistance if they need it. The message is sent to the contact numbers he has recorded by this program. There are three main actions that may be taken to complete the evaluation, each of which is explained separately. Three main phases make up the evaluation, which outlines the software's entire development.

Entering the contact information in the developed application is the first important step. These people might be our friends, family, or the top police officer of the city in which we now reside. Therefore mentioned contact information should be entered when the app is first loaded on the mobile device. Inputting contact information into the application that has been made is the first significant step.

We may have these connections with now-former the town's top policeman, as well as relatives as families. Please provide the above contact information when installing the program on your smartphone for the first time. Only once the device is turned on and linked to the correct mobile network can Every stage's process will conclude (satellite navigation).

The labour involved in consistently sending The following primary stage consists of sending all associated connections a message with the location Address. Given that duration period for the present situation was a brief period, a short message is sent to the registered contacts following every five-minute period has passed. As a result, the program can follow the person's precise position continually, attaining its essential aim that was proposed system rescuing its individual.

GPS Module: This module is designed to give the user two security-related alternatives, including Not Safe and Track. The purpose of the "Not Safe" button is to shield users from their surroundings if they feel unsafe. The GPS system uses alerts to notify the nearby hospital when the user chooses this option. The individual's position and location are tracked by the location satellites system determine their Right now of residence. It also uses GSM to send a pre-saved emergency message to registered mobile contacts and nearby hospitals. The "Track" button was designed to safeguard users who feel uneasy when using public transportation. She will receive a notice when she selects this option. Both the registered contact numbers and the local police station will receive a message. She might select the Safe option once she arrived safely at her destination.

Locating the location: A satellite navigation system in orbit, the Global Positioning System (GPS) offers position with timing details under conditions, from any location either somewhere close to the planet wherever a minimum of four GPS satellites can be seen without obstruction. Our devices' GPS is always only turned on. The program turns on and instructs using the global positioning system (GPS) follow whereabouts of the individual when phone shakes. Individual location ought to be automatically determined by the GPS. The precise position of the user is

derived using the Latitude and Longitude information. The server stores the location that was found. Through GPS, the software may also determine the location of the user's friends and nearby police station

With certain mile limit on their present location, this feature allows the individual to view the closest police station and hospital. Emergency calling systems can be classified into two categories: Automatic and The individual had turned on automatic dialling. The standard address for which it is sent had been assigned at that point of development. Calls the User Has Authorized: This function allows the person using it to pick the particular kind of hospital. is exclusive to hospitals. When the user selects this option, Google Maps shows the location of the local hospital. [20]

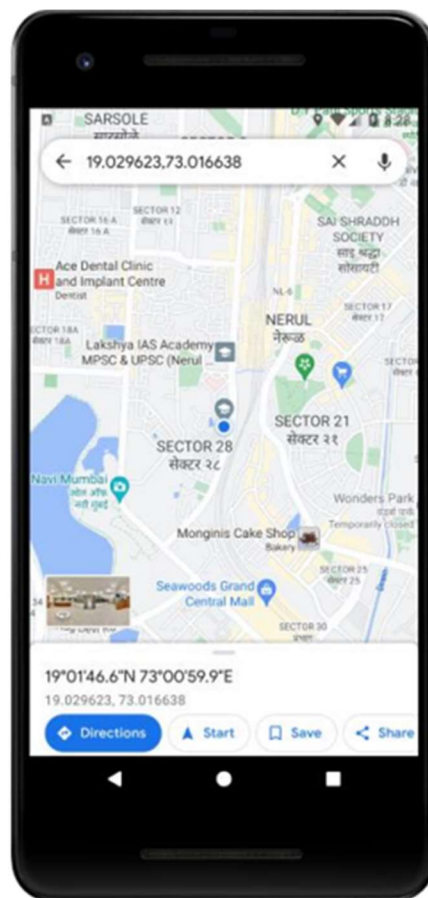

Figure 7. display displayed following an internet address tap in the notification that the mobile item obtained.

ANALYSIS

It features like Secure Login provide privacy Protection: Safe login reduces the possibility of unintentional exposure and possible exploitation of sensitive data by guaranteeing that users' private information is protected. User authentication: Securing the platform by ensuring that only

authorized users may access its capabilities is made possible by solid authorization procedures. Encryption standards is to safeguard user credentials and avert possible breaches during the login process, it is imperative that you utilize industry-standard encryption algorithms. User-Friendly Experience: To promote mass adoption, it is essential to strike a balance between security and user ease. Achieving this balance guarantees that customers won't encounter needless obstacles when using the software. Emergency panic is to quick Reaction: In an instance of danger, the crisis fear function is a lifesaver that helps users immediately call for assistance, improving their own safety. Connection with Critical Service:

Integrating into rescue services enables quick reaction times, which may cut down on response times and enhance the quality of results in emergency situations. Taking into account. User Interface Design which will efficacy of the feature depends on having an emergency button that is simple to use and accessible, especially under high-stress circumstances. Protection of Fake Alerts Putting in place safeguards against false alarms, such a confirmation step, guarantees the dependability and legitimacy of the critical fear function and Situational Awareness that giving consumers relevant updates improves their knowledge of security-related facts, possible hazards, and preventative measures and finally Empowerment via Information is a consistent updates provide women with the details they need to make educated choices regarding their safety and move more confidently throughout their environment.

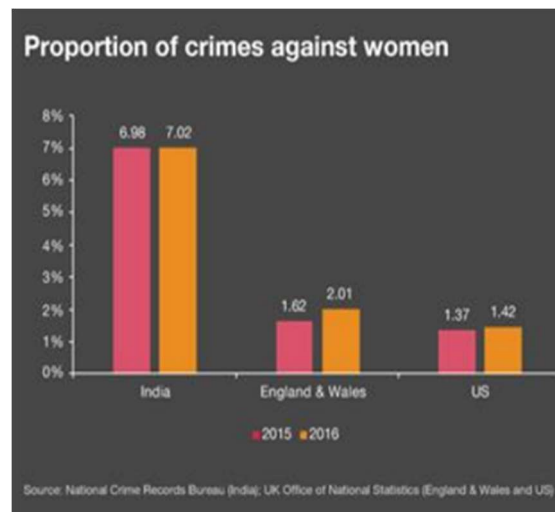

Figure 8. Statistics of international crime records

CONCLUSION

In this study, we suggested creating and deploying an application as a women's safety system. The objectives were effectively met by building a location tracking subsystem, then applicable results was given. The structure shall enlarged accordance to future goals outlined throughout the framework. The use of GPS is additionally addressed in the study. and how latitudes and longitudes can be utilized to track the victim's movements.

Today, the inexorable worldwide urbanization tsunami that is taking place has attracted the attention of academics because it is revealing complex relationships between political economics, social dynamics, safety, and community structures. In the midst of the massive wave of advancement that is changing urban environments, there is a parallel current that is characterized by a growing sense of vulnerability and alienation among social groups that have historically been marginalized because of their age, sexual orientation, gender identity, socioeconomic class, or immigration status. This need for protection is clearly seen in the glaring denial or restricted access to the plethora of options the city offers, which causes a noteworthy negative consequence for these excluded groups' Well-being. As a result, individuals have to deal with a variety of demands while negotiating the complexity of metropolitan surroundings.

Gender is one of the many axes of discrimination and exclusion, and as such, it plays a crucial and important role. As such, its ramifications within the changing urban setting must be thoroughly explored. The way that cities change and adapt makes gender dynamics a crucial component of the complex conversation around urbanization. Different experiences of people with distinct sexual orientations are highlighted, drawing attention to differences in who may access public places, assets, and basic services.

Despite one's own circumstances, the effects are felt in the larger context of disadvantaged groups' everyday lives, highlighting the critical need for a detailed investigation of urban policies and social structures that sustain gender-based disparities. The issues encountered by those with special needs in urban contexts are made even more complicated by the interconnectedness of characteristics including age, sexual orientation, migratory status, and class. Movement inside the metropolis becomes complicated for these groups because they have to negotiate not just physical barriers but also cultural customs and aspirations.

The urban landscape, which is sometimes praised for offering opportunity, becomes a contentious area where structural injustices are made glaringly obvious. In order to effectively address these intricacies, policy-making, economic actions, and development plans must adopt a comprehensive and nuanced knowledge.

Essentially, the story of globalization is told like a complicated tapestry that intertwines hopes for advancement with fears of susceptibility and marginalization. It becomes essential for the creation of inclusive policies and efforts to comprehend the complex interactions between political, social, and economic factors. For marginalized populations, especially those coping with the complex issues brought on by prejudice based on gender, this awareness is of special significance. When considering how urban areas will develop in the future, it is critical that we accept our shared duty to create conditions that support equity, fairness, and a feeling of inclusion for all.

Since the women's safety application can exclusively focus on women's safety, girls can benefit much from it. We are able to notify our contacts, the hospital, and by shaking a cell phone at police

stations. Additionally, the app's messaging feature notifies those in the vicinity of one another. The application as a whole promotes women's safety

FUTURE SCOPE

It has room for further development in the future. Every day, computer technology discovers new techniques and advancements in technology. It doesn't seem static; it's dynamic. In a few days, the abilities that are in demand now will become outdated. In order to stay up with technological advancements, the system might be further enhanced. Thus, it remains unresolved. However, with more improvements, it will continue to improve better. It is possible to do augmentations in an efficient way. We can even inform them of these modifications and integrate them with little to no modification. Because of this, The endeavor may continually evolve with novel, innovative functions since it is flexible.

This smartphone application comes in handy in the future in case of any travel-related issues or other situations. With the advancement of technology, the system can be upgraded to accommodate a desired the surroundings. Since object-oriented design is its foundation [18], any additional modifications can be readily upgraded. Emerging technology can enhance security in light of potential safety concerns.

REFERENCES

[1] Ravi Sekhar Yarrabothula Bramarambika Thota, "ABHAYA: AN ANDROID APP FOR THE SAFETY OF WOMEN," IEEE ,1 December 2015.

[2] Alisha Maruti Gawade, Amruta Jadhav and Sachin Shankar Kumbhar, "S-ZONE:A SYSTEM FOR WOMEN SAFETY & SECURITY SYSTEM," Journal of Information, Knowledge And Research In Electronics And Communication Engineering ISSN: 0975 – 6779| Nov 16 To Oct 17 | Volume – 04, Issue – 02.

[3] Sagar Khan, Harish Shinde, Ankita Zaroo, Rashmi Koushik , F. S. Ghodichor, "SHIELD: Personal Safety Application," IRJET Volume: 04 Issue: 05 , May -2017.

[4] Piyush Bhanushali, Rahul Mange, Dama Paras, Prof. Chitra Bhole, "Women Safety Android App," IRJET Journal - Volume 5 Issue4, April 04 , 2018.

[5] N. Ramesh Kannan , S. Sujitha, S. Ganapathy Subramanian, "Women Safety Mobile App," International Journal on Cybernetics & Informatics (IJCI) Vol. 10, No.1/2, May 2021.

[6] V. R. Balaji, N. Paramanandham, and M. Murugan, "Guardian device for women—A survey and comparison study," in Proc. 2nd Int. Conf. Robotics, Intell. Automat. Control Technol., Chennai, India, 2021, Art. no. 012030.

[7] L. F. Cardoso, S. B. Sorenson, O. Webb, and S. Landers, "Recent and emerging technologies: Implications for women's safety," Technol. Soc., vol. 58, Aug. 2019, Art. no. 101108.

- [8] K. M. Opika and C. M. S. Rao, "An evolution of women safety system: A literature review," Int. Bilingual Peer Reviewed Peered Res. J., vol. 10, no. 40, pp. 61–64, 2020.
- [9] S. Das, S. Dasar, and J. S. Rao, "Women's security system," Int. J. Eng. Res. Technol. (IJERT), vol. 10, no. 7, pp. 483–486, 2021.
- [10] Abhaya: An Android App for the safety of women. IEEE journal paper available from <http://ieeexplore.ieee.org/document/7443652/>.
- [11] Suraksha. A device to help women in distress: An initiative by a student of ITM University Gurgaon. efytimes.com. 2013. Available from: <http://efytimes.com/e1/118387/SURAKSHA-A-Initiative-By-A-Student-Of-ITM-UniversityGurgaon.pdf>
- [12] Women Safety Device and Application-FEMME. An initiative by Sathyabama University, Chennai.
- [13] STHREE RAKSHA -AN ANDROID APP Prof. Yadhu Naik1, Prof. VITTAL KUMAR K VAGGA 2, Deepa. M3 1B.H Dept. of MCA, VIAT Bangalore, India
- [14]. " SCREAM ALARM", Android app developed by GoPalAppMaker in November, 2013 <https://play.google.com/store/apps/details?id=gopal.appmaker.android.com&hl=en> Volume 7, Issue 3, May-June-2021 | <http://ijsrceit.com> Dr. K Srinivas et al Int. J. Sci. Res. Comput. Sci. Eng. Inf. Technol, May-June - 2021, 7 (3) : 378-386 386
- [15]. Saranya, J.; Selvakumar, J., "Implementation of children tracking system on android mobile terminals," 2013 IEEE International Conference on Communications and Signal Processing (ICCSP), vol., no., pp.961,965, 3-5 April 2013.
- [16]. Android Studio Development Essentials Book by Neil Smit
- [17] MAGESH KUMAR.S and RAJ KUMAR.M, "IPROB – EMERGENCY APPLICATION FOR WOMEN" ISSN 2250- 3153 International Journal of Scientific and Research Publications, online at www.ijsrp.org Volume 4, Issue 3, March 2014
- [18] Dr. Sridhar Mandapati, SravyaPamidi and Sriharitha Ambati, "A Mobile Based Women Safety Application (I Safe Apps)"
- [19] IJCSMC, Vol. 8, Issue. 10, October 2019, pg.54 – 59 ANDROID APP FOR WOMEN SECURITY SYSTEM
- [20] Android App for Women Safety Dr. K Srinivas*1 , Dr. Suwarna Gothanel , C. Saisha Krithika2 , Anshika2 , T. Susmitha2